

TOOL KIT

Setbacks

Surface Mount:

Wall Setback: The Tool Kit should be at least 12" from a wall. Both sides of the Tool Kit should be 36" from either wall.

No part of the Tool Kit should protrude onto a walkway, bike lane, or common area.

Street Setback: The Tool Kit should be at least 60" from the street.

Wall Mount:

Wall Setback: The Tool Kit should be mounted on a wall at least 54" from the ground to the center of the Tool Kit. The Tool Kit should be 36" from an adjacent wall.



DERO
A PLAYCORE Company

www.dero.com | 1-888-337-6729

TOOL KIT

Installation Instructions – Surface Mount

TOOLS NEEDED

Tape Measure
Marker or Pencil
Masonry Drill Bit
Drill (Hammer drill recommended)
Hammer
Wrench 9/16"
Level

RECOMMENDED BASE MATERIAL

Solid concrete is the best base material for installation. To ensure the proper anchors are shipped with your Tool Kit, ask your Dero Tool Kit representative which anchor is appropriate for your application. Be sure nothing is underneath the base material that could be damaged by drilling.

1

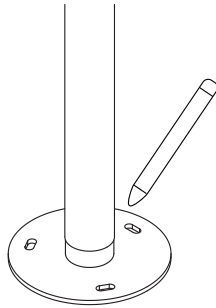

Place the Tool Kit in the desired location. Use a marker or pencil to outline the holes of the flange onto the base material.

2

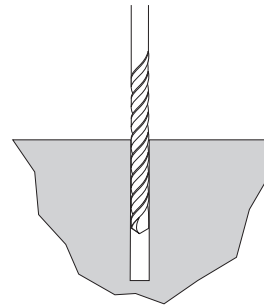

Drill 3/8" diameter holes 3" deep into surface. Make sure the holes are at least 3" away from any cracks in the base material.

3

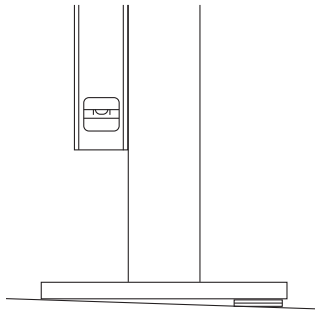

Place Tool Kit (and washers to level rack if necessary) over holes.

4

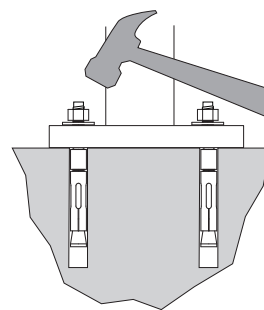

Thread nuts onto anchors, leaving approximately 1/4" of the anchor protruding, and tap into surface. Tighten nuts down to secure the stand.



DERO
A PLAYCORE Company

www.dero.com | 1-888-337-6729

TOOL KIT

Installation Instructions – Wall Mount

1

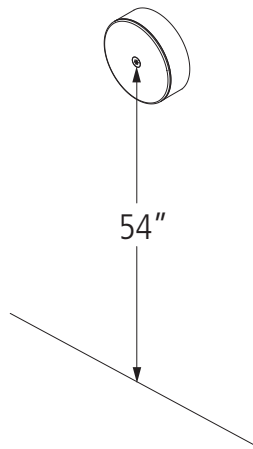

The Tool Kit wall-mount should be installed with the center of the Tool Kit 54" above the ground.

2

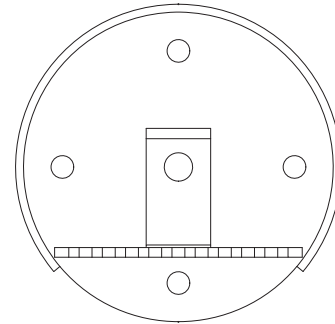

There are 4 mounting holes; only 2 need to be used. For installations into a vertical stud, use the 2 vertically oriented holes. The horizontally oriented holes can be used for other types of installation. 3/8" wedge anchors, lag bolts, or other fasteners may be used.

3

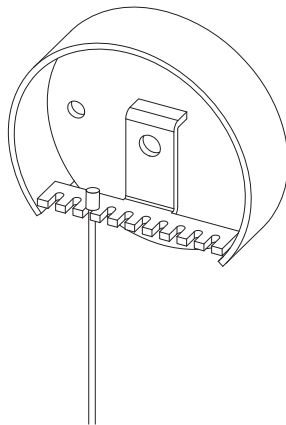

Once the base is installed, place the tool cables in the slots, and fasten the cap with the provided 3/8" tamper-resistant bolt.



DERO
A PLAYCORE Company

www.dero.com | 1-888-337-6729