

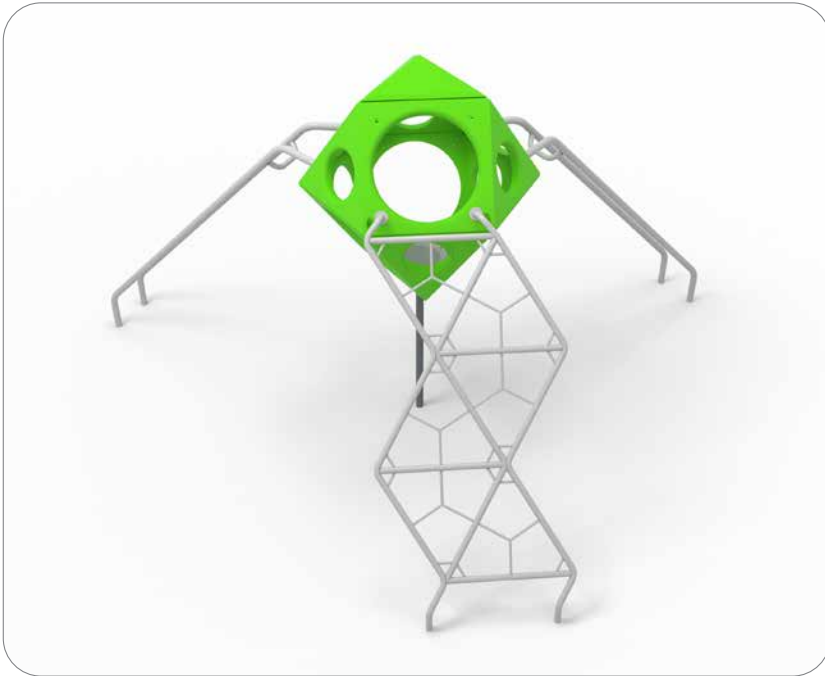

Multi Functional Play Equipment • PlayCubes



m²
35

2.05

5-12

6

Pictor 1.3

8077737 Green Plastic 8077733 Red Plastic

8077767 Green Steel 8077794 Red Steel

CC Cast in Place

6,55 x 5,20

For more details please visit our website:
www.hags.com

A perfect PlayCube combination for children who seek height!

Adventurers can tackle the challenging ladder from the front or, those wanting to take their climbing skills to a whole new level, can attempt to climb it from underneath.

Once at the top, children can race down the Banister Rails or take a rest and socialise in the PlayCube as they pretend to be inside a treehouse, high above the forest!

Play Values

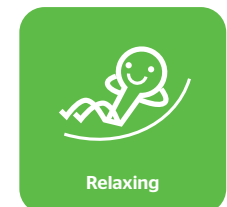
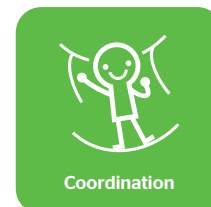
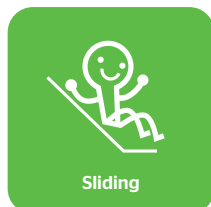
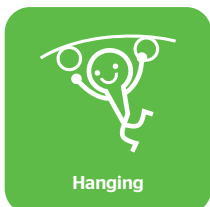



Multi Functional Play Equipment • PlayCubes

Pictor 1.3

Age Range	5-12
Users	6
Length (m)	4,4
Width (m)	4,1
Height (m)	2,7
Net Weight (kg)	210
Fall Height (m)	2,05
Safety Area W (m)	7,05
Safety Area L (m)	7,45
Surface (m ²)	35

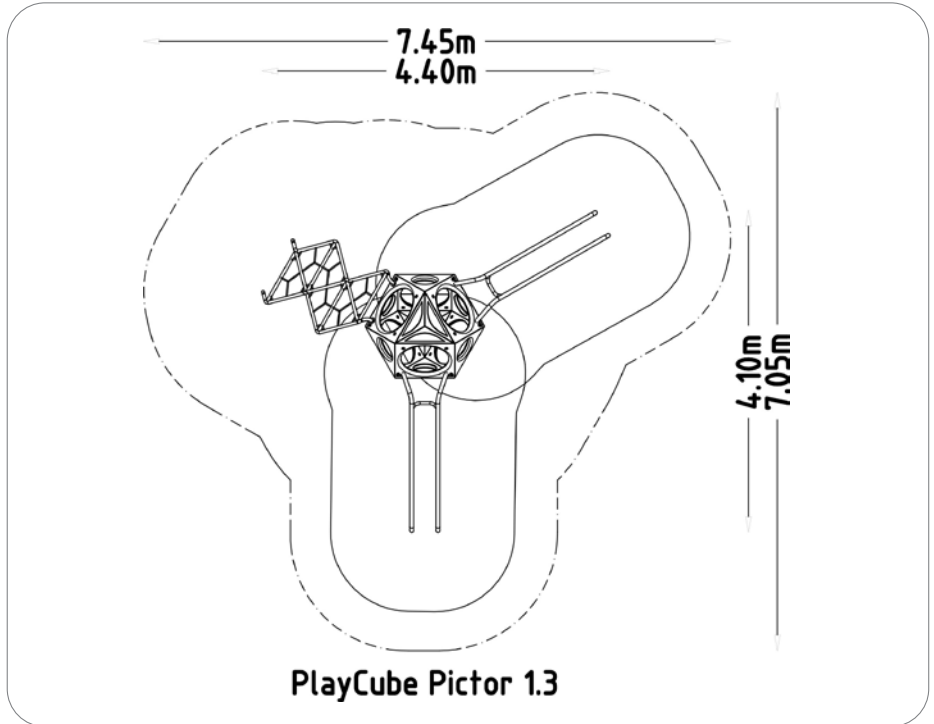

Technical Specification

Architectural Play equipment comprising of 1 No. 1245mm high cuboctahedrons available in shatter proof Rotomolded LLDPE (Linear Low Density Polyethene) or perforated steel, assembled with stainless steel fixings. Steel parts are powder coated (for steel option).

Pictor combination stands at a combined height of 2.7m. Includes access and egress via a triangle ladder and 2 banister rail components fabricated from hollow steel sections to EN 10305-3 and powder coated. Product designed and certified to EN1176.

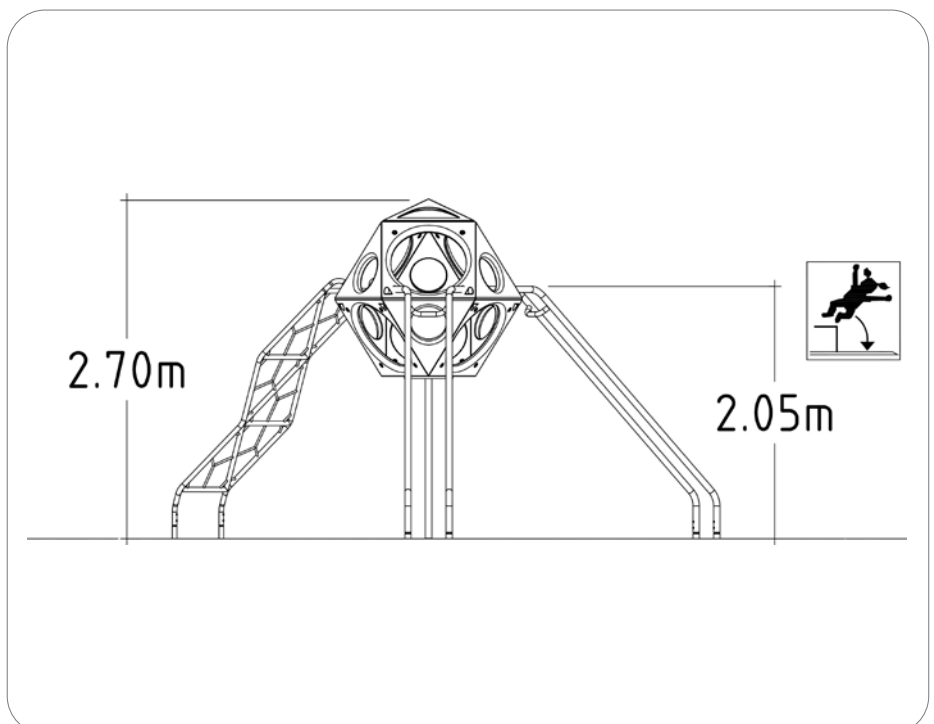

Assembly time



Recommended age



Accessible



Free height of fall
EN 1176



Space needed



Impact area
EN 1176



No. of
Users